



LUXALON®

Cell Ceiling

Hunter Douglas Cell Ceilings enable architects to design an open ceiling with high-performance aluminium. With a wide variety of cells and patterns, these ceilings offer maximum freedom in design.

HunterDouglas

CEILING

Cell Ceiling

Endless possibilities

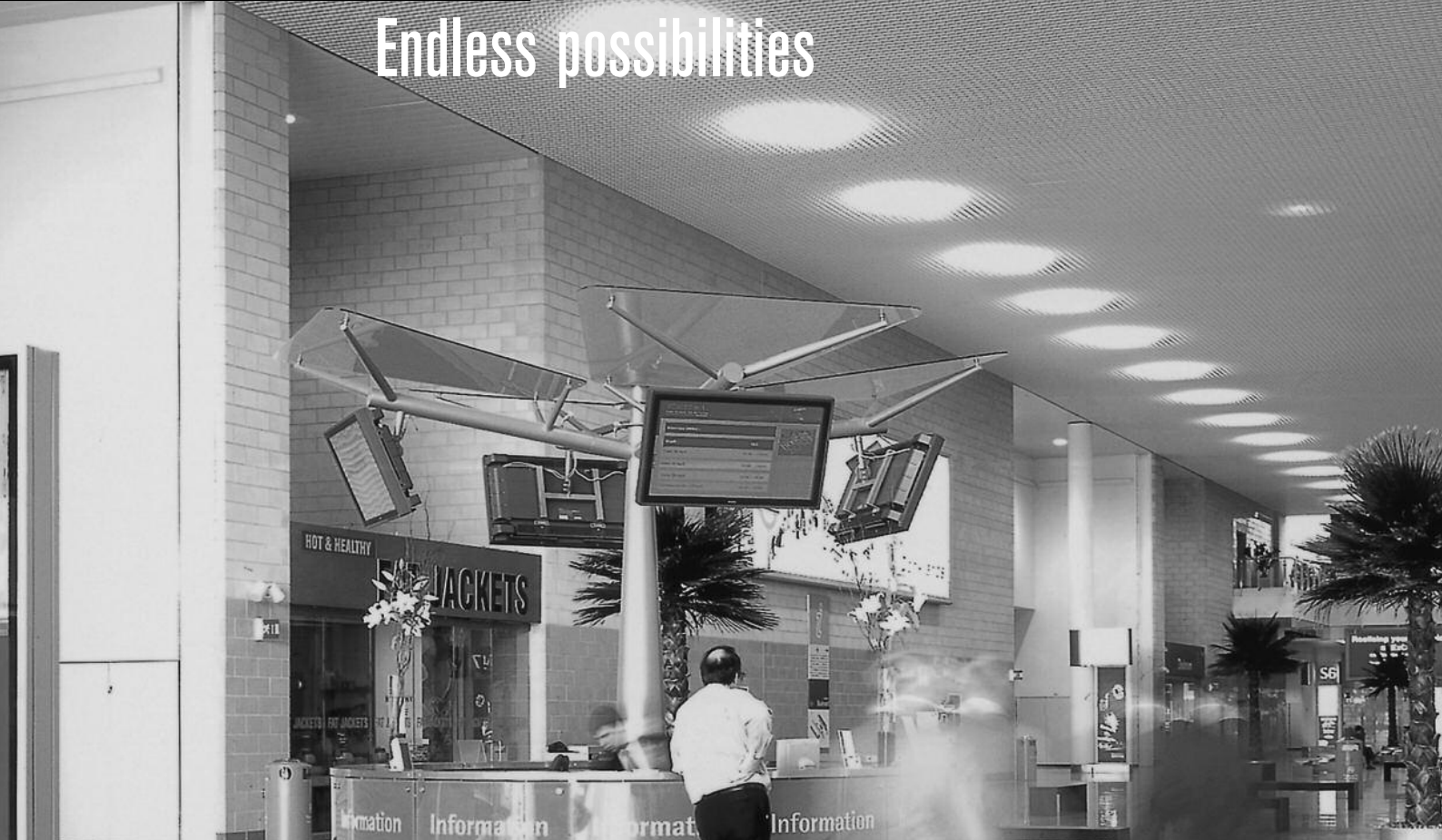

DESIGN FLEXIBILITY

Cell Ceiling systems create a spacious appearance ideal for interior designs where open, light constructions are desired. They make it easy to create different modules in one ceiling and are ideal for very small plenum depths. Systems are available as sliding, hook-in, swing-down or tile. Modules vary from 17 x 17 mm to 200 x 300 mm. A wide range of colours and finishes are available, and special colours can be provided upon request.

DURABILITY

Manufactured from 0.35, 0.4, 0.5, or 0.6 mm thick pre-painted aluminium coil, Cell Ceilings are finished with a polyester paint to provide a long, low-maintenance life. The coating is stove-enameled in a continuous coil-coating process to ensure uniform thickness and absolute adhesion.

EASY PLENUM ACCESS

The panels can be easily (de)mounted by hand, allowing for full interaction with systems and installation in the plenum.

FIRE BEHAVIOUR

All Luxalon® metal suspended ceilings are classified A2, s1, d0 according to EN 13501-1. Hunter Douglas Open Cell creates a ceiling through which large amounts of air and or smoke can be extracted, a distinct advantage in escape routes where the clearest visibility is required.



Our Open Cell Ceilings help define a space and create interesting shadows and lighting effects. Available in a range of sizes and colours, our Cell Ceilings provide a plenum mask that ensures creativity is the focal point.

We offer two Open Cell Ceilings:

- Cell tiles, a standard-sized product
- Cell systems, flexible and modular

CONTENT

Page

| | | |
|------------------|-----------------|----|
| Tiles | Unigrid | 2 |
| | T15 | 3 |
| Systems | Linagrid | 4 |
| | Cell 40 | 5 |
| | Cell 50E | 6 |
| | Cell 22 | 7 |
| | Cell 50 | 8 |
| | Combicell 22/50 | 9 |
| Perimeter | Solutions | 10 |
| Material | Specifications | 11 |

Innovative Products Make Innovative Projects



Production by
Hunter Douglas
Ceiling Center



HunterDouglas

Unigrid

TILES

These square or rectangular tiles are available in four styles. Their small size and the available variety of types help give the ceiling a highly decorative aspect.

SUSPENSION

The 600 x 600 mm or 600 x 1200 mm tiles are laid on, laid in, or concealed on a T24 or T15 grid.

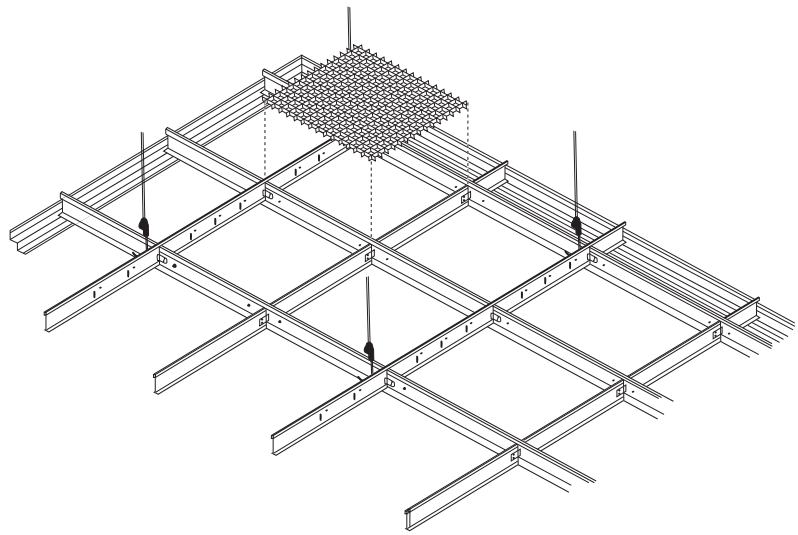

1. Lay-on (T24/T15)

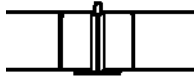

2. Lay-in (T24/T15)

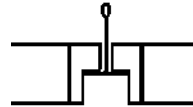

3. Concealed (T24)

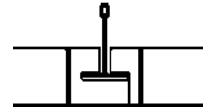

STYLE TYPES

- Focal : the face is flat
- Wave : the face is undulating
- Crête : the face has an angular pattern
- Piquée: the face is flat, the strips are perforated with vertical oblong perforations

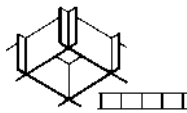

Type Focal

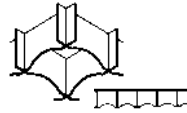

Type Wave

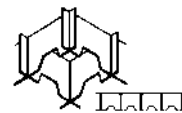

Type Crête

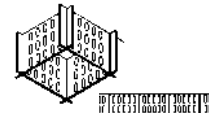

Type Piquée

MODULES AND WEIGHT

Tiles are made from 0.6 mm thick aluminium strip.

Other modules and heights available.

WEIGHT (KG/M²)

| Module | 20 x 20 | 25 x 25 | 30 x 30 | 40 x 40 | 50 x 50 |
|-----------|---------|---------|---------|---------|---------|
| Height 20 | 3.36 | 2.85 | 2.28 | 1.59 | |
| Height 25 | | 3.35 | 2.77 | 2.10 | 1.68 |

MODULES AND HEIGHTS (Availability)

The modules and style types are available in white, aluminium and black.

Other modules and heights available.

| Module | Height | | |
|---------|--------|-----------|----|
| 17 x 17 | 17 | 50 x 50 | 25 |
| 20 x 20 | 17 | 60 x 60 | 25 |
| 25 x 25 | 17 | 30 x 30 | 30 |
| 20 x 20 | 20 | 35 x 35 | 30 |
| 25 x 25 | 20 | 40 x 40 | 30 |
| 30 x 30 | 20 | 50 x 50 | 30 |
| 35 x 35 | 20 | 60 x 60 | 30 |
| 40 x 40 | 20 | 50 x 50 | 50 |
| 25 x 25 | 25 | 55 x 55 | 50 |
| 30 x 30 | 25 | 60 x 60 | 50 |
| 35 x 35 | 25 | 75 x 75 | 50 |
| 40 x 40 | 25 | 90 x 90 | 50 |
| | | 100 x 100 | 50 |

NUANO

Type Piquée with inclined profiles at 45°. These tiles create special decorative light effects.

Standard module 30 x 34 mm

Height 20 mm

Other modules on request.

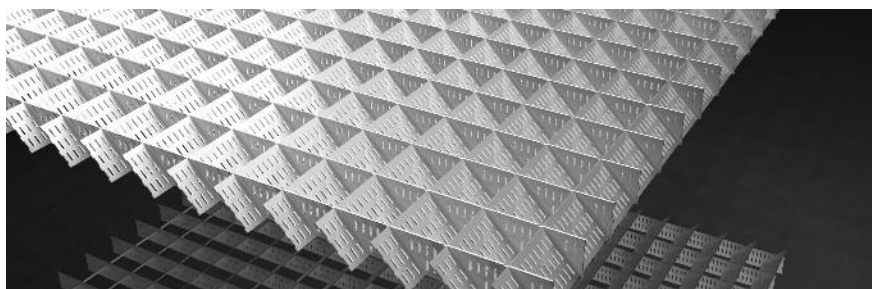

T15

TILES

The T15 tiles are assembled from aluminium U-profiles.

SUSPENSION

The 600 x 600 mm or 600 x 1200 mm tiles are laid in a T15 grid.

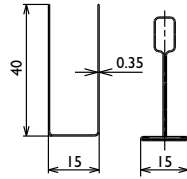
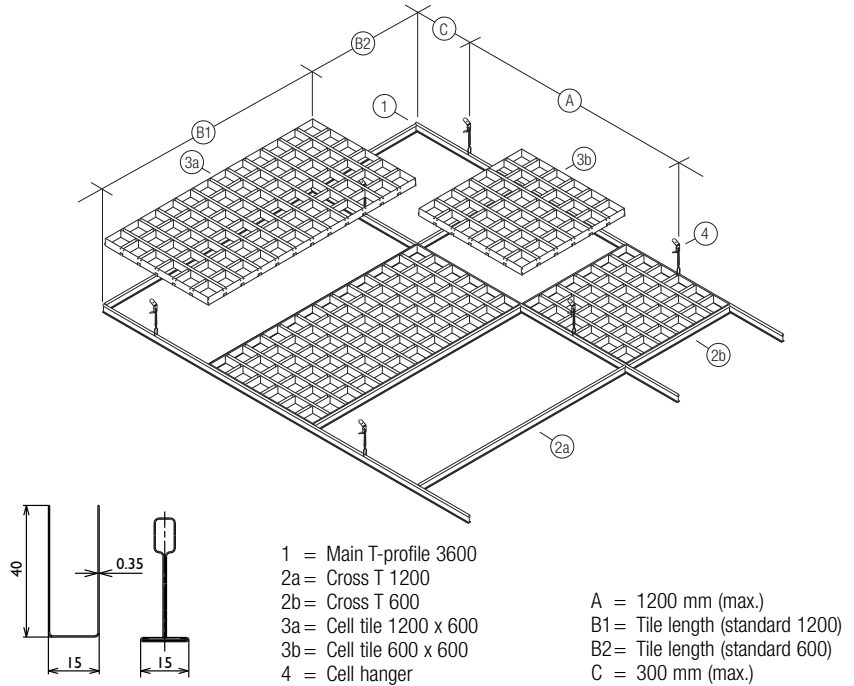

CONSTRUCTION DETAILS

The standard L edge profile can be used

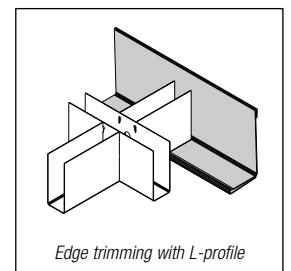
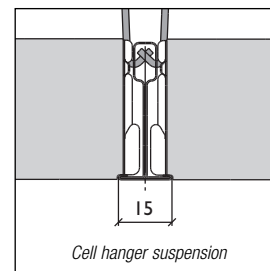
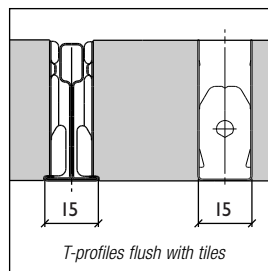
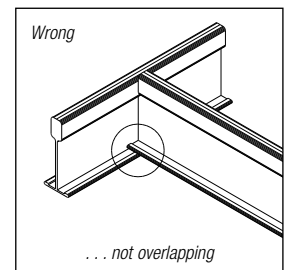
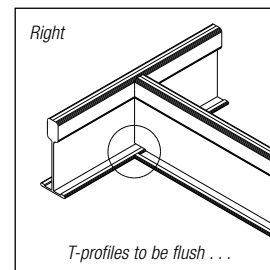
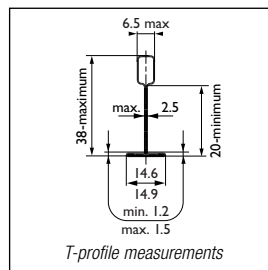

MODULES, WEIGHTS AND VIEWING ANGLE

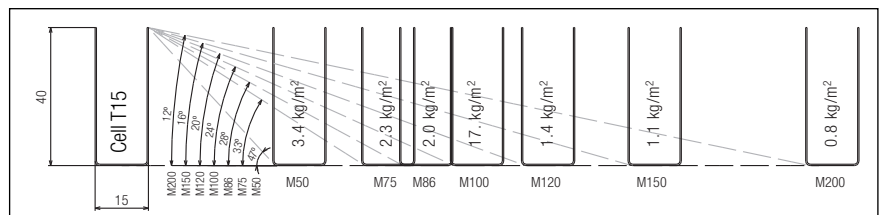

MODULES AND HEIGHTS (Availability)

The panels are made from 0.35 mm thick aluminium strip.

| Module | Height | 100 x 100 | 40 |
|---------|--------|-----------|----|
| 50 x 50 | 40 | 120 x 120 | 40 |
| 75 x 75 | 40 | 150 x 150 | 40 |
| 86 x 86 | 40 | 200 x 200 | 40 |

MATERIAL REQUIREMENT PER M²

Edge profile type and quantity is subject to individual project requirements.

| | Unit | Cell T15 Tile 1200 x 600 | Cell T15 Tile 600 x 600 |
|-----------------------|------|--------------------------|-------------------------|
| Cell T15 tiles | pcs | 1.39 | 2.78 |
| 15 mm T-grid (non HD) | lm | 2.50 | 3.34 |
| Cell hangers | pcs | 0.69 | 0.69 |

Linagrid

PANELS

Linagrid panels (600 x 1200 mm) are pre-assembled from U-shaped aluminium profiles. These profiles are clipped into U-shaped supporting spacer profiles.

SUSPENSION

The panels are hung into the suspended U-shaped main runners, forming an economical, integrated linear grid ceiling.

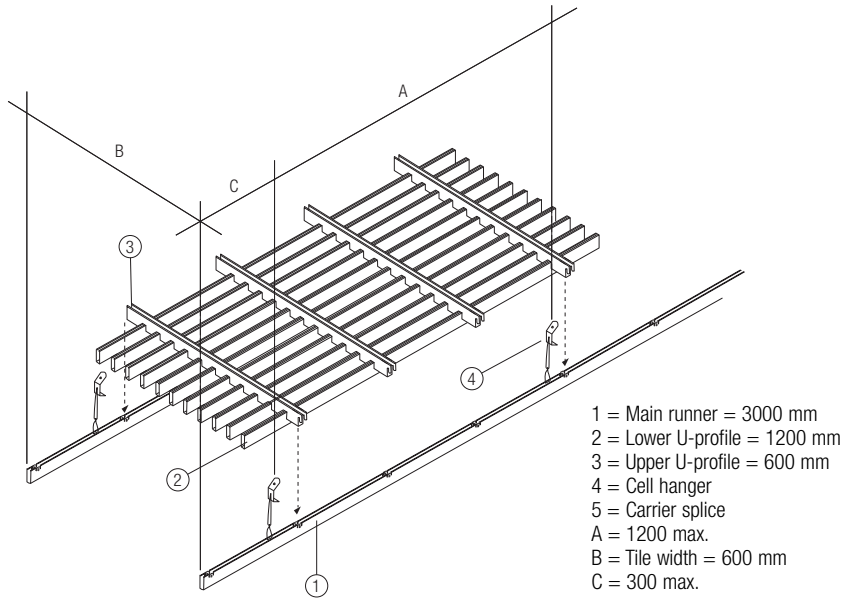

- 1 = Main runner = 3000 mm
- 2 = Lower U-profile = 1200 mm
- 3 = Upper U-profile = 600 mm
- 4 = Cell hanger
- 5 = Carrier splice
- A = 1200 max.
- B = Tile width = 600 mm
- C = 300 max.

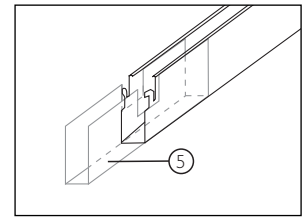
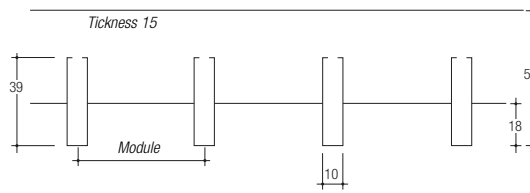

SWING DOWN SYSTEM

The Linagrid ceiling is also available in a swing-down version, which allows easy interaction with the plenum.

The standard range of edge profiles can be used. Adapter panels cannot swing down.

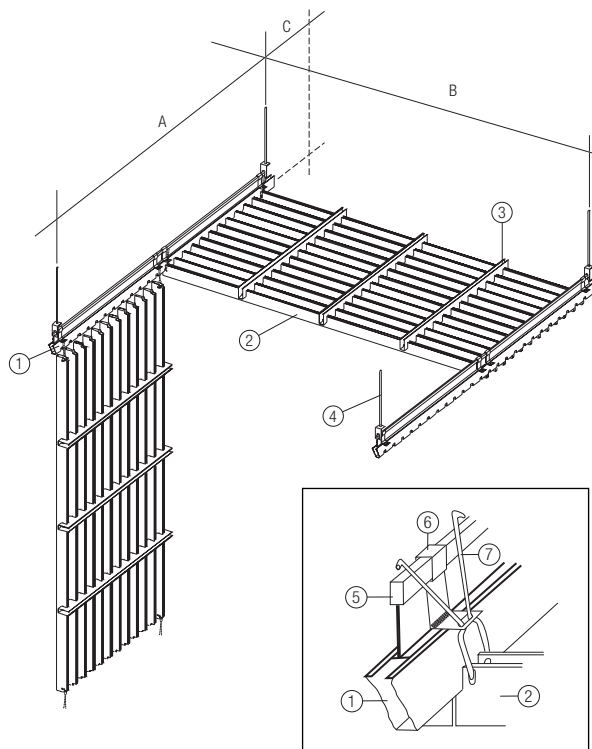

- 1 = Main runner = 3000 mm
- 2 = Lower U-profile = 1200 mm
- 3 = Upper U-profile = 600 mm
- 4 = Suspension
- 5 = Standard profile T15 (non HD)
- 6 = Mounting clip
- 7 = Swing-down spring
- A = 1200 max.
- B = 1200 mm
- C = 300 max.

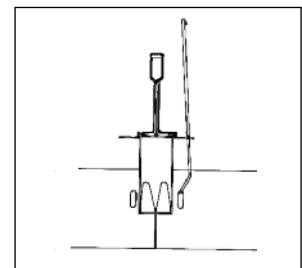
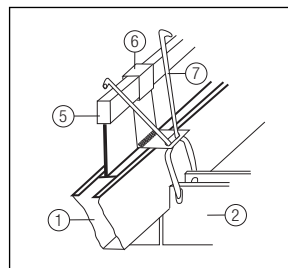

MODULES, WEIGHTS AND VIEWING ANGLE

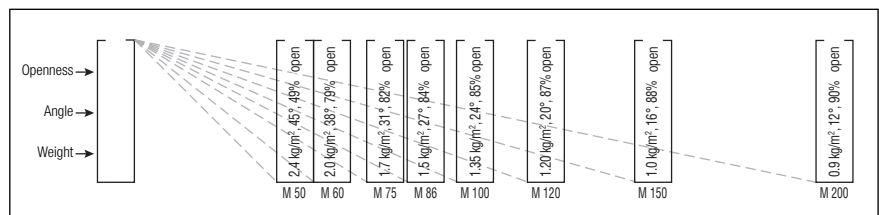

MODULES AND HEIGHTS (Availability)

The panels are made from 0.4 mm thick aluminium strip.

| Module | Height |
|-----------|--------|
| 50 x 300 | 56 |
| 60 x 300 | 56 |
| 75 x 300 | 56 |
| 80 x 300 | 56 |
| 100 x 300 | 56 |
| 120 x 300 | 56 |
| 150 x 300 | 56 |
| 200 x 300 | 56 |

Cell 40

PANELS

Cell 40 panels are assembled from aluminium U-profiles to create an integrated system.

SUSPENSION

The 600 x 600 mm or 600 x 1200 mm panel sizes feature an integrated suspension system with main and cross runners made from the same profiles as the cell panel.

- 1 = Main runner 2400 mm
- 2a = Cross runner 1200 mm
- 2b = Cross runner 600 mm
- 3a = Cell tile 1200 x 600 mm (pre-notched hooks)
- 3b = Cell tile 600 x 600 mm (pre-notched hooks)
- 3c = Cell tile 1200 x 600 or 600 x 600 mm (straight ends, for sliding clip)
- 4 = Cell hanger

- A = 1200 mm (max.)
- B1 = Tile length (standard 1200)
- B2 = Tile length (standard 600)
- C = 300 mm (max.)

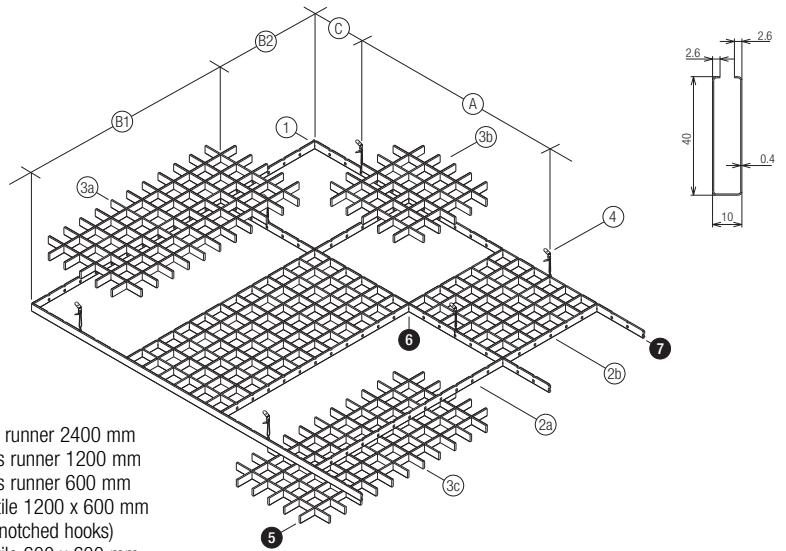

CONSTRUCTION DETAILS

The panel ends can be used in two different installation options:

- Integrated hooks that hook into main and cross runners.
- Clean cut ends accepting sliding clips.

These options can be combined in one ceiling.

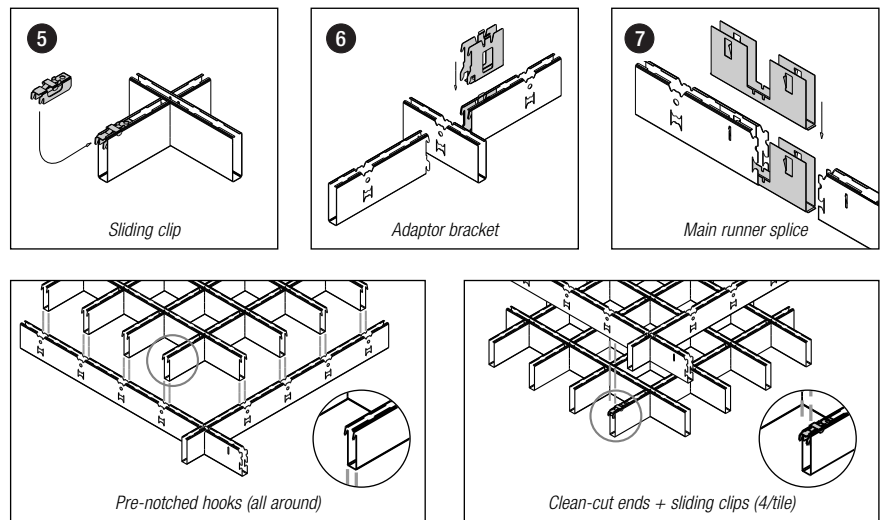

MODULES, WEIGHTS AND VIEWING ANGLE

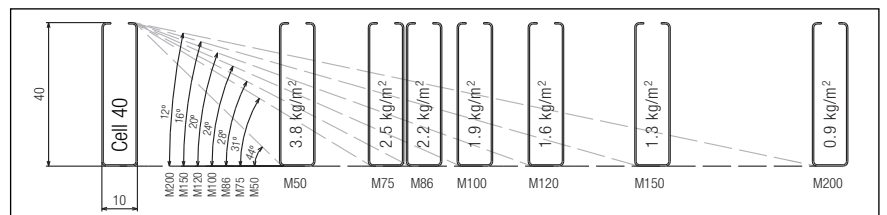

MODULES AND HEIGHTS (Availability)

Tiles are made from 0.4 mm thick aluminium strip.

| Module | Height |
|-----------|--------|
| 50 x 50 | 40 |
| 75 x 75 | 40 |
| 86 x 86 | 40 |
| 100 x 100 | 40 |
| 120 x 120 | 40 |
| 150 x 150 | 40 |
| 200 x 200 | 40 |

MATERIAL REQUIREMENT PER M²

Edge profile type and quantity is subject to individual project requirements.

* only for tiles with straight ends

| | Unit | Cell 40 Tile 1200 x 600 | Cell 40 Tile 600 x 600 |
|--------------------|------|-------------------------|------------------------|
| Cell 40 tiles | pcs | 1.39 | 2.78 |
| Main Runners 2400 | lm | 0.83 | 1.67 |
| Cross Runners 1200 | lm | 1.67 | |
| Cross Runners 600 | lm | | 1.67 |
| Sliding Clips* | pcs | 5.56 | 11.12 |
| Splices | pcs | 0.35 | 0.70 |
| Cell Hangers | pcs | 0.69 | 1.39 |

Cell 50E

PANELS

Cell 50E panels are assembled from aluminium U-profiles. They create perfect detailing of the connecting U-profiles, which are designed to conceal uncoated edges.

SUSPENSION

The 600 x 600 mm and 600 x 1200 mm panels feature an integrated system with main and cross runners from the same profiles as the panels.

The panels are easily (de)mounted with the sliding clips.

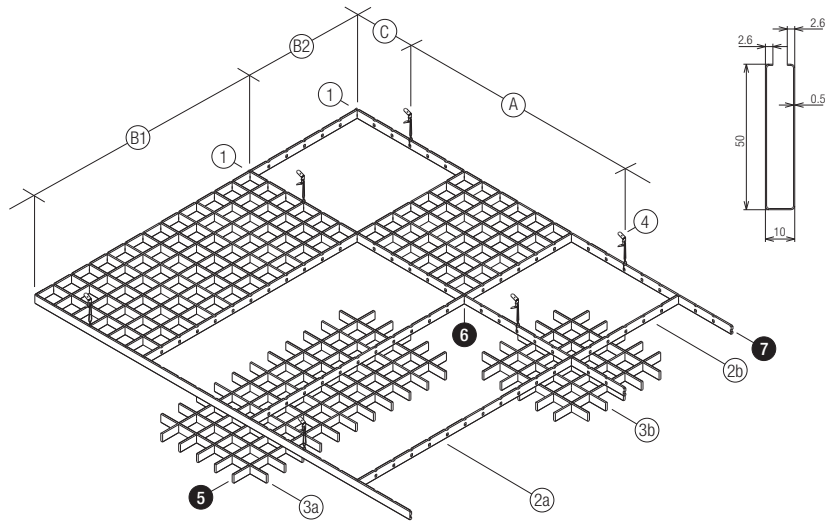

- 1 = Main runner 2400 mm
- 2a = Cross runner 1200 mm
- 2b = Cross runner 600 mm
- 3a = Cell tile 1200 x 600 mm
- 3b = Cell tile 600 x 600 mm
- 4 = Cell hanger
- A = 1200 mm (max.)
- B1 = Tile length (standard 1200)
- B2 = Tile length (standard 600)
- C = 300 mm (max.)

CONSTRUCTION DETAILS

The standard range of edge profiles can be used.

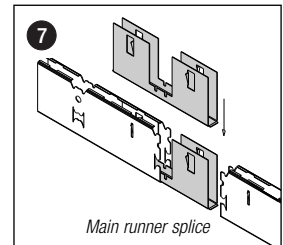
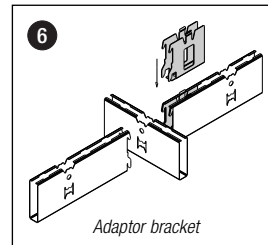
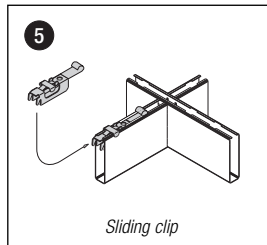

MODULES, WEIGHTS AND VIEWING ANGLES

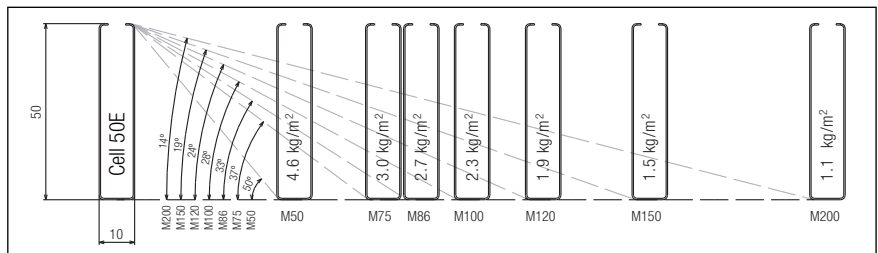

MODULES AND HEIGHTS (Availability)

Tiles are made from 0.4 mm thick aluminium strip.

| Module | Height |
|-----------|--------|
| 100 x 100 | 50 |
| 50 x 50 | 50 |
| 120 x 120 | 50 |
| 75 x 75 | 50 |
| 150 x 150 | 50 |
| 86 x 86 | 50 |
| 200 x 200 | 50 |

MATERIAL REQUIREMENT PER M²

Edge profile type and quantity is subject to individual project requirements.

| | Unit | Cell 50E Tile 1200 x 600 | Cell 50E Tile 600 x 600 |
|--------------------|------|--------------------------|-------------------------|
| Cell 50E tiles | pcs | 1.39 | 2.78 |
| Main Runners 2400 | lm | 0.83 | 1.67 |
| Cross Runners 1200 | lm | 1.67 | |
| Cross Runners 600 | lm | | 1.67 |
| Sliding Clips | pcs | 5.56 | 11.12 |
| Splices | pcs | 0.35 | 0.70 |
| Cell Hangers | pcs | 0.69 | 1.39 |

Cell 22

PANELS

Cell 22 panels are assembled from aluminium U-profiles and create perfect detailing of the connecting U-profiles, which are designed to conceal uncoated edges.

SUSPENSION

The 600 x 600 mm and 600 x 1200 mm panels feature an integrated system with main and cross runners from the same profiles as the panels. The panels are easily (de)mounted with the sliding clips.

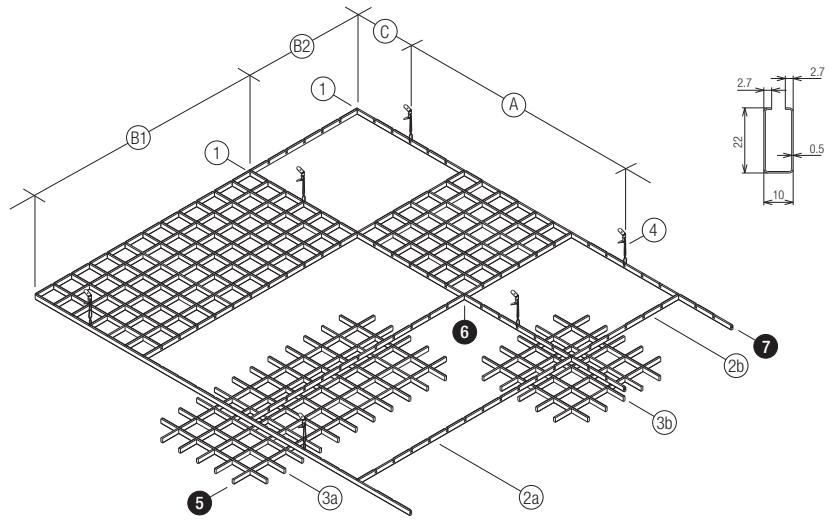

- 1 = Main runner 2400 mm
- 2a = Cross runner 1200 mm
- 2b = Cross runner 600 mm
- 3a = Cell tile 1200 x 600 mm
- 3b = Cell tile 600 x 600 mm
- 4 = Cell hanger
- A = 900 mm (max.)
- B1 = Tile length (standard 1200)
- B2 = Tile length (standard 600)
- C = 300 mm (max.)

CONSTRUCTION DETAILS

The standard range of edge profiles can be used.

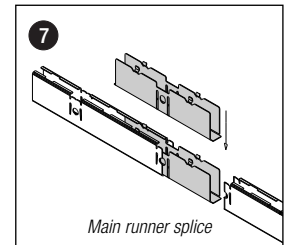
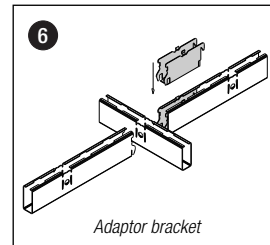
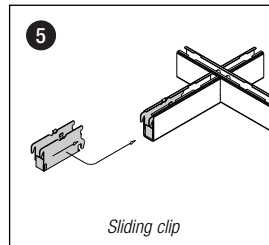

MODULES, WEIGHTS AND VIEWING ANGLES

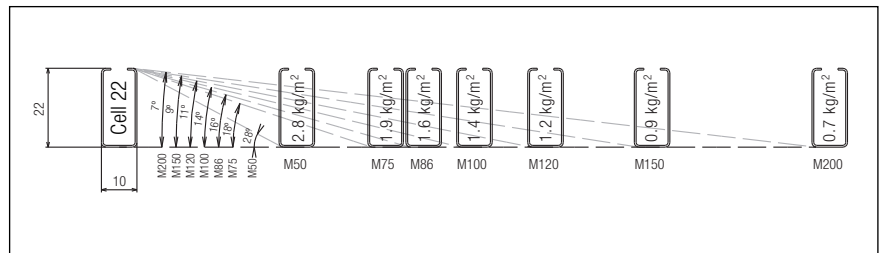

MODULES AND HEIGHTS (Availability)

Tiles are made from 0.5 mm thick aluminium strip.

| Module | Height | 100 x 100 | 22 |
|---------|--------|-----------|----|
| 50 x 50 | 22 | 120 x 120 | 22 |
| 75 x 75 | 22 | 150 x 150 | 22 |
| 86 x 86 | 22 | 200 x 200 | 22 |

MATERIAL REQUIREMENT PER M²

Edge profile type and quantity is subject to individual project requirements.

| | Unit | Cell 22 Tile 1200 x 600 | Cell 22 Tile 600 x 600 |
|--------------------|------|-------------------------|------------------------|
| Cell 22 tiles | pcs | 1.39 | 2.78 |
| Main Runners 2400 | lm | 0.83 | 1.67 |
| Cross Runners 1200 | lm | 1.67 | |
| Cross Runners 600 | lm | | 1.67 |
| Sliding Clips | pcs | 8.34 | 11.12 |
| Splices | pcs | 0.35 | 0.70 |
| Cell Hangers | pcs | 0.93 | 1.85 |

Cell 50

PANELS

Cell 50 panels are assembled from aluminium U-profiles and create perfect detailing of the connecting U-profiles, which are designed to conceal uncoated edges.

SUSPENSION

The 600 x 600 mm and 600 x 1200 mm panels feature an integrated system with main and cross runners from the same profiles as the panels.

The panels are easily (de)mounted with the sliding clips.

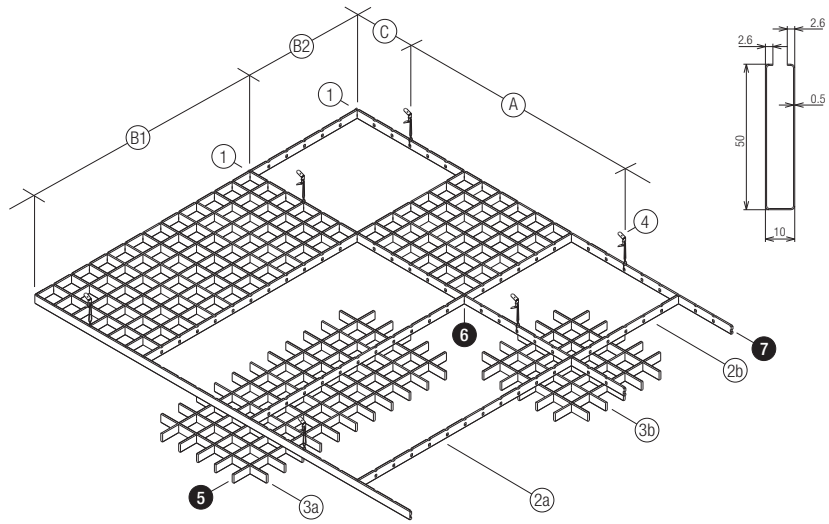

- 1 = Main runner 2400 mm
- 2a = Cross runner 1200 mm
- 2b = Cross runner 600 mm
- 3a = Cell tile 1200 x 600 mm
- 3b = Cell tile 600 x 600 mm
- 4 = Cell hanger

- A = 1200 mm (max.)
- B1 = Tile length (standard 1200)
- B2 = Tile length (standard 600)
- C = 300 mm (max.)

CONSTRUCTION DETAILS

The standard range of edge profiles can be used.

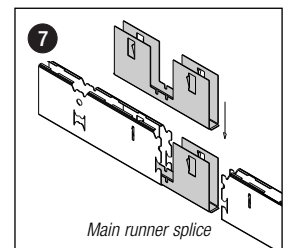
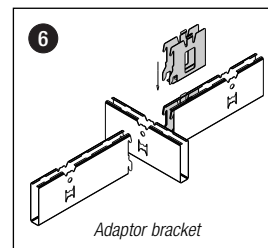
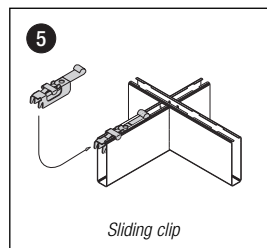

MODULES, WEIGHTS AND VIEWING ANGLES

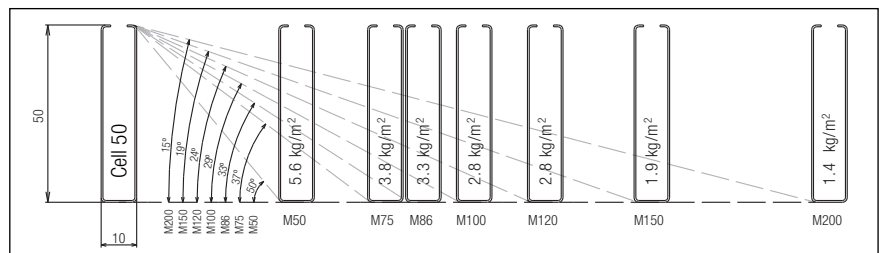

MODULES AND HEIGHTS (Availability)

Tiles are made from 0.5 mm thick aluminium strip.

| Module | Height | 100 x 100 | 50 |
|---------|--------|-----------|----|
| 50 x 50 | 50 | 120 x 120 | 50 |
| 75 x 75 | 50 | 150 x 150 | 50 |
| 86 x 86 | 50 | 200 x 200 | 50 |

MATERIAL REQUIREMENT PER M²

Edge profile type and quantity is subject to individual project requirements.

| | Unit | Cell 50 Tile 1200 x 600 | Cell 50 Tile 600 x 600 |
|------------------------|------|-------------------------|------------------------|
| Cell 50 tiles | pcs | 1.39 | 2.78 |
| Main Runners 2400 | lm | 0.83 | 1.67 |
| Cross Runners 1200 | lm | 1.67 | |
| Cross Runners 600 | lm | | 1.67 |
| Sliding Clips/Brackets | pcs | 5.56 | 11.12 |
| Splices | pcs | 0.35 | 0.70 |
| Cell Hangers | pcs | 0.69 | 1.39 |

Combicell

PANELS

Cell 22 and 50 types can be combined in one cell ceiling. This option can be used with different cell levels to create variation or to mark specific areas.

SUSPENSION

The 600 x 600 mm and 600 x 1200 mm panels feature an integrated system with main and cross runners from the same profiles as the Cell 50 panels.

The panels are easily (de)mounted with the sliding clips.

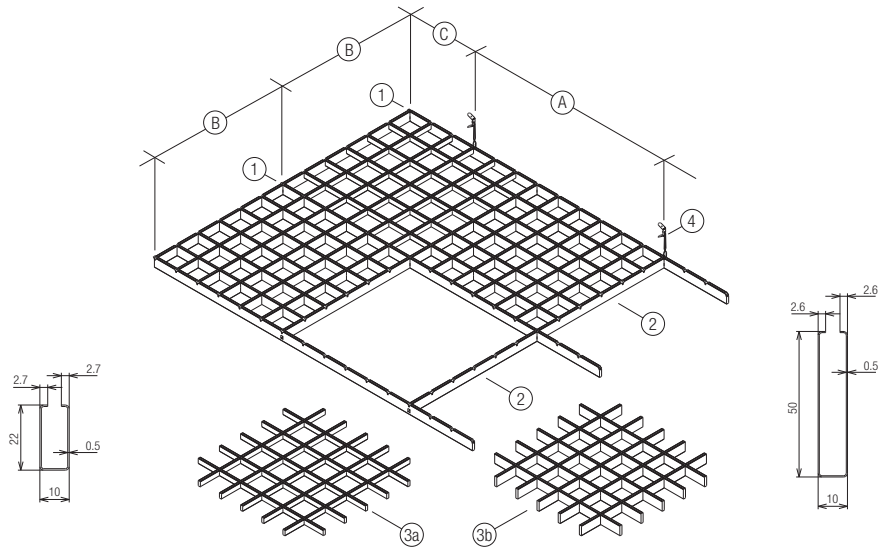

- 1 = Cell 50 main runner 2400 mm
- 2 = Cell 50 cross runner 600 mm
- 3a = Cell tile 22
- 3b = Cell tile 50
- 4 = Cell hanger

- A = 1200 mm (max.)
- B = Tile length (standard 600 mm)
- C = 300 mm (max.)

COMBINATIONS OF TILES WITH DIFFERENT MODULES

There are a limited number of possibilities for combining tiles with different modules in one Combicell ceiling.

| Grid with profile module | Accepts tiles with modules |
|--------------------------|----------------------------|
| 100 mm | 100 and 50 mm |
| 150 mm | 150, 75, 50 mm |
| 200 mm | 200, 100, 50 mm |

MATERIAL REQUIREMENT PER M²

Edge profile type and quantity is subject to individual project requirements.

| | Unit | Cell 50 | Cell 50 | Cell 22 | Cell 22 |
|------------------------|------|---------------------|--------------------|---------------------|--------------------|
| | | Tiles 1200 x 600 | Tiles 600 x 600 | Tiles 1200 x 600 | Tiles 600 x 600 |
| Cell 50 or 22 tiles | pcs | 1.39 | 2.78 | 1.39 | 2.78 |
| Main Runners 2400 | lm | 0.83 | 1.67 | 0.83 | 1.67 |
| Cross Runners 1200 | lm | 1.67 | | 1.67 | |
| Cross Runners 600 | lm | | 1.67 | | 1.67 |
| Sliding Clips/Brackets | pcs | 5.56 | 11.12 | 8.34 | 11.12 |
| Splices | pcs | 0.35 | 0.70 | 0.35 | 0.70 |
| Cell Hangers | pcs | 0.69 | 1.39 | 0.93 | 1.86 |

Perimeter

STANDARD PERIMETER OPTIONS

Cell 40, 50E and 50

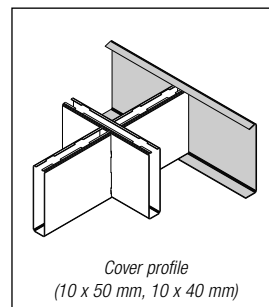
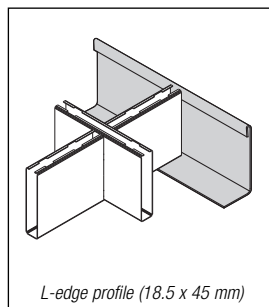
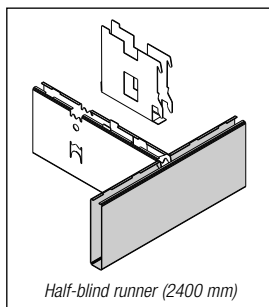

STANDARD PERIMETER OPTIONS

Cell 22

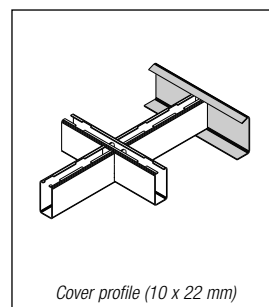
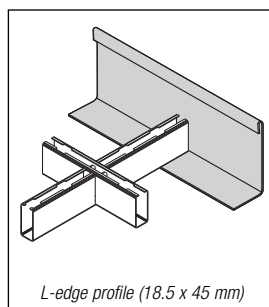
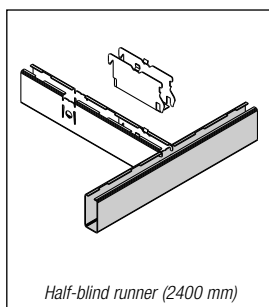

EDGE PROFILES

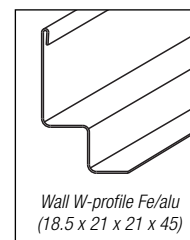
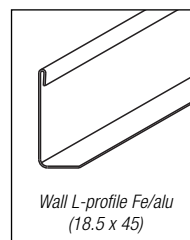
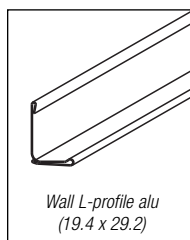

CELL DIMENSIONS

Standard dimensions are 600 x 600 mm and 600 x 1200 mm. Other sizes on request.

Material



We are dedicated to manufacturing sustainable products. Our paint and aluminium melting processes are considered to be an industry standard in terms of clean production processes. All of our aluminium products are 100% recyclable at the end of their lifecycle.

SPECIFICATIONS

- Base Material

Cell Ceiling systems are manufactured from aluminium alloy HD5050 or equal (according to EN 1396, and EN 13523 Series).

- Coating

The tough and durable 2-layer polyester finish in a nominal thickness of 20 microns is stove enameled in a continuous coil-coating process to ensure uniform coating thickness and absolute adhesion.

- Colour range

The standard Hunter Douglas interior colour range for Cell Ceiling systems includes a wide variety of colours and finishes. For more information, see our colour chart. Any other (RAL or NCS) colour is available upon request.

- Tolerances

As a member of the Technical Association of Industrial Metal Ceiling Manufacturers (TAIM), Hunter Douglas complies with tolerance criteria as specified in the TAIM Quality standards for metal ceilings.

- Fire Behaviour

Hunter Douglas metal suspended ceilings are classified A2, s1, d0 according to EN 13501-1, and therefore will not contribute to fires. Hunter Douglas Open Cell creates a ceiling through which large amounts of air and or smoke can be extracted, a distinct advantage in escape routes where the clearest visibility is required.

- Plenum Accessibility

Hunter Douglas Cell Ceiling systems allow for easy (de)mounting of the panels. The standard panels are easily lifted upwards and removed, allowing full access to systems and installations in the plenum. The minimum free space for comfortable (de)mounting is 130 mm. The swing-down systems allow for (de)mounting the panels downward, with the panels swinging and remaining suspended to allow for easy interaction with the plenum.

The sliding clips allow for (de)mounting of the panels from below for cases where there is no handling space in the plenum.

HUNTER DOUGLAS ARCHITECTURAL PRODUCTS

In the last 50 years, we've been fortunate enough to help turn countless innovative sketches into innovative buildings.



Architects, designers, investors and contractors from around the world have taken advantage of Hunter Douglas' unmatched product development, service and support. Chances are, you've seen more of Hunter Douglas than you think.

With major operation centres in Europe, North America, Latin America, Asia and Australia, we've contributed to thousands of high-profile projects, from retail and commercial facilities to major transit centres and government buildings.

Not only are the world's architects and designers our partners, they're our inspiration. They continue to raise the bar for excellence. We create products that help bring their visions to life: Window Coverings, Ceilings, Sun Control Systems and Façades.



Promoting sustainable
forest management
www.pefc.org



Hunter Douglas products and solutions are designed to improve indoor environmental quality and conserve energy, supporting built environments that are comfortable, healthy, productive, and sustainable.



Our paint and aluminium melting processes are considered to be one of the industry standards in terms of clean production processes. All aluminium products are 100% recyclable at the end of their lifecycle.

ARCHITECTURAL SERVICES

We support our business partners with a wide range of technical consulting and support services for architects, developers and installers. We assist architects and developers with recommendations regarding materials, shapes and dimensions and colours and finishes. We also help creating design proposals, visualisations and mounting drawings. Our services to installers range from providing detailed installation drawings and instructions to training installers and advising on the building site.



HunterDouglas

CEILING



HUNTER DOUGLAS is a publicly traded company with activities in more than 100 countries with over 150 companies.

The origin of our company goes back to 1919, in Düsseldorf, Germany. Throughout our history, we have introduced innovations that have shaped the industry, from the invention of the continuous aluminium caster, to the creation of the first aluminium Venetian Blinds, to the development of the latest high-quality building products.

Today we employ more than 16,500 people in our companies with major operation centres in Europe, North America, Latin America, Asia and Australia.

Innovative Products Make Innovative Projects

© Registered trademark - a HunterDouglas® product Pats. & Pats. Pend. - Technical data subject to change without notice. © Copyright Hunter Douglas 2014. No rights can be derived from copy, text pertaining to illustrations or samples. Subject to changes in materials, parts, compositions, designs, versions, colours etc., even without notice. MX074C00

Learn More

- Contact our Sales office
- www.hunterdouglascontract.com

Wide Panel

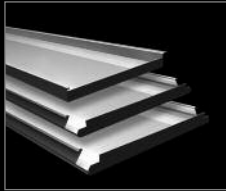

Linear

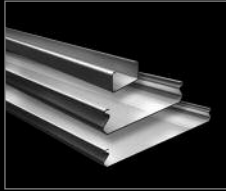

Screen



Tiles
XL panel

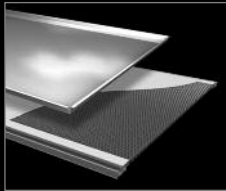

Cell
Stretch metal

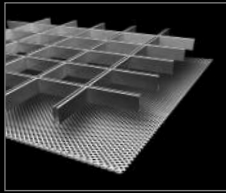

Curved

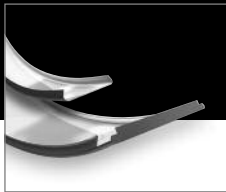

Exterior

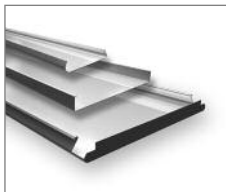

- Belgium
- Bulgaria
- Croatia / Slovenia
- Czechia
- Denmark
- France
- Germany
- Greece
- Hungary
- Italy
- The Netherlands
- Norway
- Poland
- Portugal
- Romania
- Russia
- Serbia
- Slovakia
- Spain
- Sweden
- Switzerland
- Turkey
- United Kingdom
- Africa
- Middle East
- Asia
- Australia
- Latin America
- North America

HUNTER DOUGLAS EUROPE B.V.
 2, Piekstraat
 P.O. Box 5072 - 3008 AB Rotterdam
 The Netherlands
 Tel. +31 (0)10 - 4869911
 Fax +31 (0)10 - 4847910
www.hunterdouglascontract.com

HunterDouglas